

photomultiplier power base (negative) PS1804 data sheet

1 description

The PS1804 is a compact photomultiplier power base, operating at negative high voltage. The CW principle of operation provides the lowest power consumption within our range of power bases. This is particularly relevant to battery operated equipment. It is suitable for use with 11 stage, 52 mm diameter, photomultipliers with an overall voltage range of -300 to -1800 V. It is available in two versions: the PS1804/5 operates from a +5 V supply and the PS1804/12 requires +12 V.

It is housed in a cylindrical metal enclosure to provide electrical screening. Low voltage connections are by 500 mm long insulated leads, and the anode output is via a 500 mm long RG174U screened coaxial cable.

The dynode potentials are provided directly to the socket contacts.

The overall operating voltage for the photomultiplier can be precisely set using any one of the three programming options shown in section 9.



Examples of the Sens-Tech's range of power bases

2 applications

The PS1804 is suitable for the following applications:

- pulsed light
- photon counting

3 features

- extremely low power consumption
- compact design
- freedom from high voltage cables
- low ripple
- exceptional voltage divider stability with varying anode current
- excellent pulse height linearity
- sleep mode

4 specification

output voltage range	-300 V to -1800 V
anode current at 1800 V	200 μ A
input current, full load (PS1804/5)	<25 mA
input current, full load (PS1804/12)	<10 mA
input current, idling (PS1804/5)	20 mA
input current, idling (PS1804/12)	7 mA
load regulation	0.005% (0-100%)
line regulation	0.005 % V^{-1}
temperature coefficient	<0.03 % $^{\circ}C^{-1}$
warm up time to 0.3 % of final output	< 10 s
discharge time to <40 V with no load	< 60 s
anode ripple with 10 k Ω 20 pF, 1 kV	5 mV p-p
external voltage control	0.3 V - 1.8 V (0-100%)
weight	80 g

5 ratings

input voltage (PS1804/5)	+5 V to +8 V
input voltage (PS1804/12)	+12 V to +15 V
control voltage	0 to +1.6 V
temperature (operating)	+5 $^{\circ}C$ to +55 $^{\circ}C$

6 schematic diagram

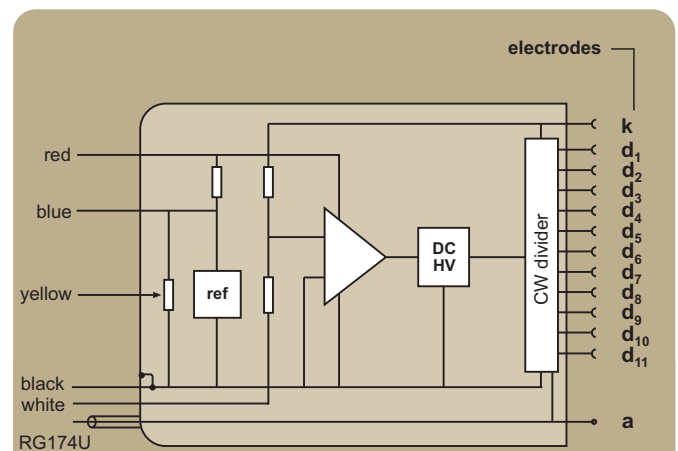

example of output voltage with 1.3 volts applied to control (white) wire

contact	electrode	voltage	contact	electrode	voltage
1	d ₁	-1100	4	d ₇	-500
14	d ₂	-1000	5	d ₈	-400
2	d ₃	-900	10	d ₉	-300
13	d ₄	-800	6	d ₁₀	-200
3	d ₅	-700	8	d ₁₁	-100
12	d ₆	-600	19	a	0
				k	-1300

7 voltage distribution

The photomultiplier pin configuration compatible with this power base is given below. Note that an anode load resistor is not included.

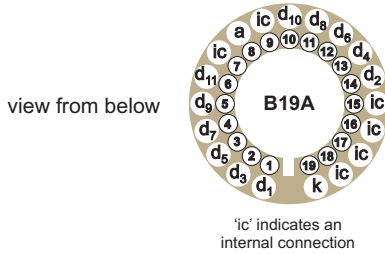

note: V is the high voltage, HV

8 sleep mode

The power consumption can be reduced by half to one third of its normal level by activating the sleep mode. This is done by taking the control voltage (white) to 0 V.

9 programming options

1) internal potentiometer (access from back of power supply, clockwise to increase HV)

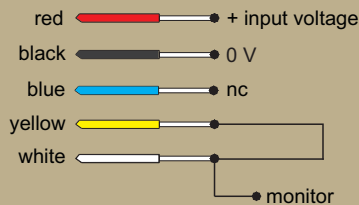

2) external potentiometer (the internal potentiometer must be set fully clockwise)

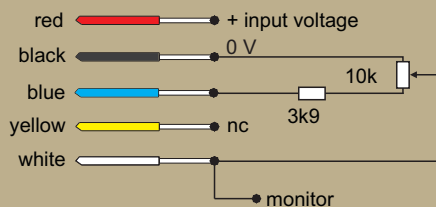

external voltage

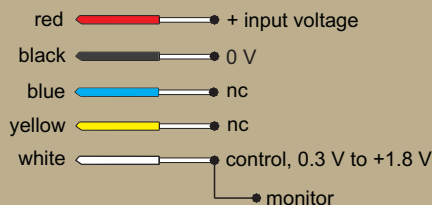

nc: no connection - isolated lead

voltage monitor: 1/1000 of the HV applied to photomultiplier

10 outline drawing (mm)

All input connections are 7/0.2 PVC covered, 0.5 m in length. The anode lead is RG174U, also 0.5 m in length.

B19A socket with optional flange shown dashed

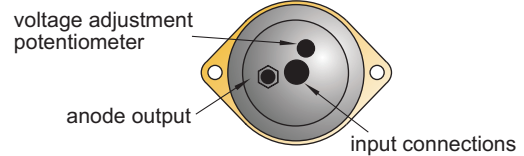
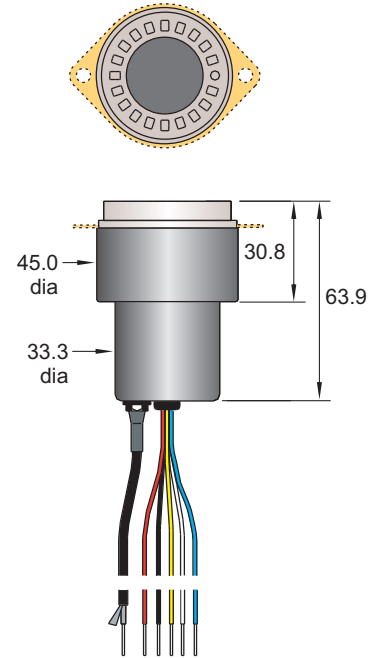

11 ordering information

item	ordering code
PS1804, +5 V	PS1804/5
PS1804, +5 V, flange	PS1804/5F
PS1804, +12 V	PS1804/12
PS1804, +12V, flange	PS1804/12F

12 warning

High voltages generated by these products present an electrical shock hazard and appropriate precautions must be taken. They must be installed by qualified personnel and operated within the specified ratings.

The PS1804 is despatched with the internal potentiometer set to zero.

Do not operate outside the ratings limit. This may result in loss of performance or permanent damage to the PS1804. Do not exceed the ratings of the photomultiplier as this may damage the photomultiplier and the power supply.