

photomultiplier power base (negative) PS1252 data sheet

1 description

The PS1252 is a compact photomultiplier power base incorporating a negative high voltage supply and an active voltage divider. It is suitable for use with all 9 stage, 30 mm diameter, capped side window photomultipliers with an overall voltage range of -100 to -1250 V. It is available in two versions: the PS1252/5 operates from a +5 V supply and the PS1252/12 requires +12 V.

It is housed in a cylindrical metal enclosure to provide electrical screening. Low voltage connections are by 500 mm long insulated leads, and the anode output is via a 500 mm long RG174U screened coaxial cable.

The internal high voltage provides power to an active divider, comprising a series of lower power FETs. Dynode potentials are generated directly on the pins of a B11A photomultiplier tube socket.

The overall operating voltage for the photomultiplier can be precisely set using any one of the three programming options shown in section 9.

The PS1252 can be supplied in a side window housing (SWH) to special order.



2 application

The PS1252 is suitable for the following applications:

- analogue
- pulsed light
- photon counting

3 features

- compact design
- freedom from high voltage cables
- extremely low ripple
- exceptional voltage divider stability with varying anode current
- excellent pulse height linearity
- sleep mode

4 specification

| | |
|---|--------------------------|
| input power at $V_{max} = -1250V$ | +5 V, 65 mA |
| power conversion efficiency, P_o / P_{in} | 40 % for +5 V |
| input power at $V_{max} = -1250 V$ | +12 V, 20 mA |
| power conversion efficiency, P_o / P_{in} | 50 % for +12 V |
| output voltage range | -100 V to -1250 V |
| line regulation | 0.05 % / V |
| temperature coefficient | <0.03 % °C ⁻¹ |
| warm up time to 0.3 % of final o/p | < 2 s |
| discharge time to <40 V with no load | < 2 s |
| maximum anode current, continuous | 100 µA |
| anode ripple with 100 k //5 pF load | 100 µV |
| weight | 60 g |

5 ratings

| | |
|---------------------------|-------------------|
| input voltage (PS1252/5) | +4.75 V to +6.0 V |
| input voltage (PS1252/12) | +12 V to +15 V |
| control voltage | 0 to +1.25 V |
| temperature (operating) | +5 °C to +55 °C |

6 schematic diagram

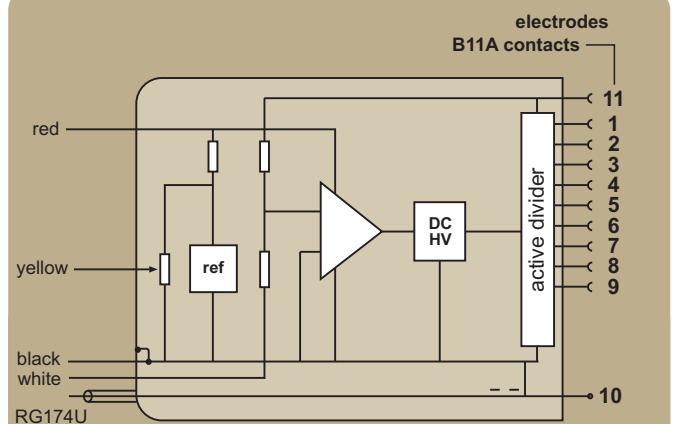

example of output voltage with 1.25 V applied to control (white) wire

| contact | electrode | voltage | contact | electrode | voltage |
|---------|----------------|---------|---------|----------------|----------|
| 1 | d ₁ | -1125 | 7 | d ₇ | -375 |
| 2 | d ₂ | -1000 | 8 | d ₈ | -250 |
| 3 | d ₃ | -875 | 9 | d ₉ | -125 |
| 4 | d ₄ | -750 | 10 | a | floating |
| 5 | d ₅ | -625 | 11 | k | -1250 |
| 6 | d ₆ | -500 | | | |

7 voltage distribution

The side window photomultiplier pin configuration compatible with this power base is given below. Note that an anode load resistor is not included.

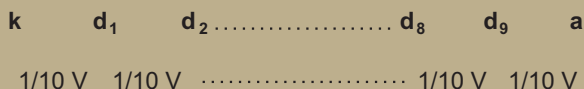
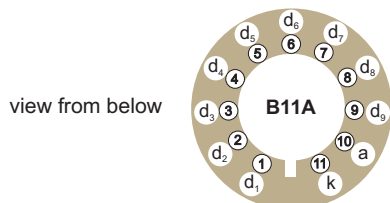

note: V is the high voltage, HV

8 sleep mode

The power consumption can be reduced by half to one third of its normal level by activating the sleep mode. This is done by taking the control voltage (white) to 0 V.

9 programming options

internal potentiometer
(access from back of power supply, clockwise to increase HV)

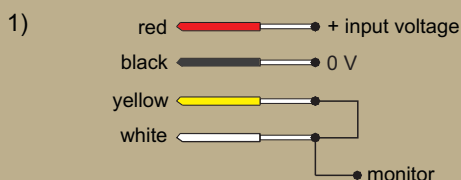

external potentiometer

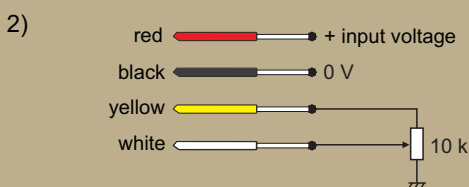

external voltage

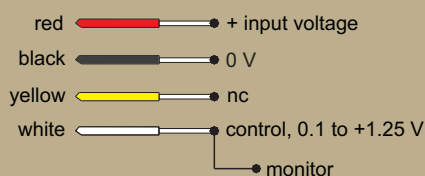

nc: no connection - isolated lead

voltage monitor: 1/1000 of the HV applied to photomultiplier

10 outline drawing(mm)

All input connections are 7/0.2 PVC covered, 0.5 m in length. The anode lead is RG174U, also 0.5 m in length.

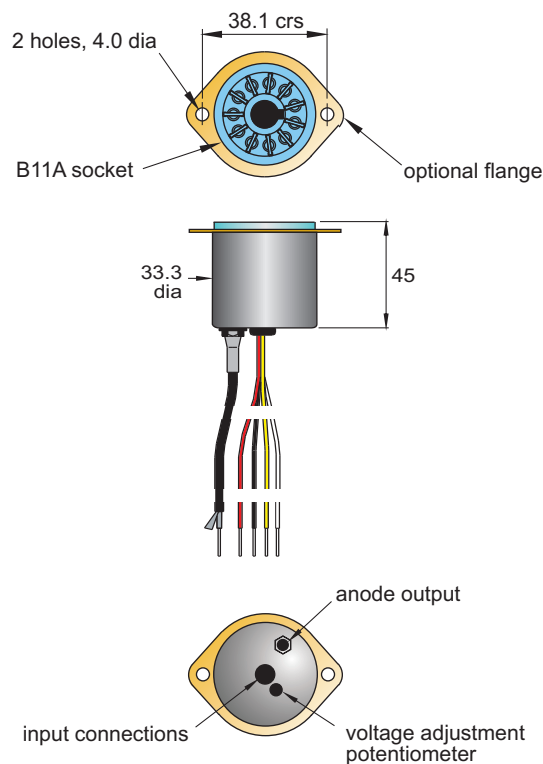

11 ordering information

| item | ordering code |
|----------------------|---------------|
| PS1252, +5 V | PS1252/5 |
| PS1252, +5 V, flange | PS1252/5F |
| PS1252, +12 V | PS1252/12 |
| PS1252, +12V, flange | PS1252/12F |

12 warning

High voltages generated by these products present an electrical shock hazard and appropriate precautions must be taken. They must be installed by qualified personnel and operated within the specified ratings.

The PS1252 is despatched with the internal potentiometer set to zero.

Do not operate outside the ratings limit. This may result in loss of performance or permanent damage to the PS1252. Do not exceed the ratings of the photomultiplier as this may damage the photomultiplier and the power supply.